

nuudo.

Neo

03

Neo

MODULAR SIMPLICITY



Discover more

Neo Modern Simplicity - a luminaire series that exudes luxurious elegance through its sleek design. Meticulously crafted with high-quality finishes and a keen eye for detail, Neo brings a touch of sophistication to any space.

Designed with versatility in mind, Neo offers recessed, surface-mounted, and pendant luminaires in the same style, promoting a sense of peace and unity throughout different areas. Its clean design, coupled with high light quality (CRI 92), ensures a captivating illumination experience.

Neo provides utmost convenience with its compatibility with Dali-, Casambi, and Triac dimmable systems. Installation is a breeze, and you can choose from gold, white, and black inner rings to match your aesthetic preferences. With its adaptability, Neo proves to be the ideal choice for various applications.

Unleash the potential of your projects with Neo's timeless appeal.





Neo POINT

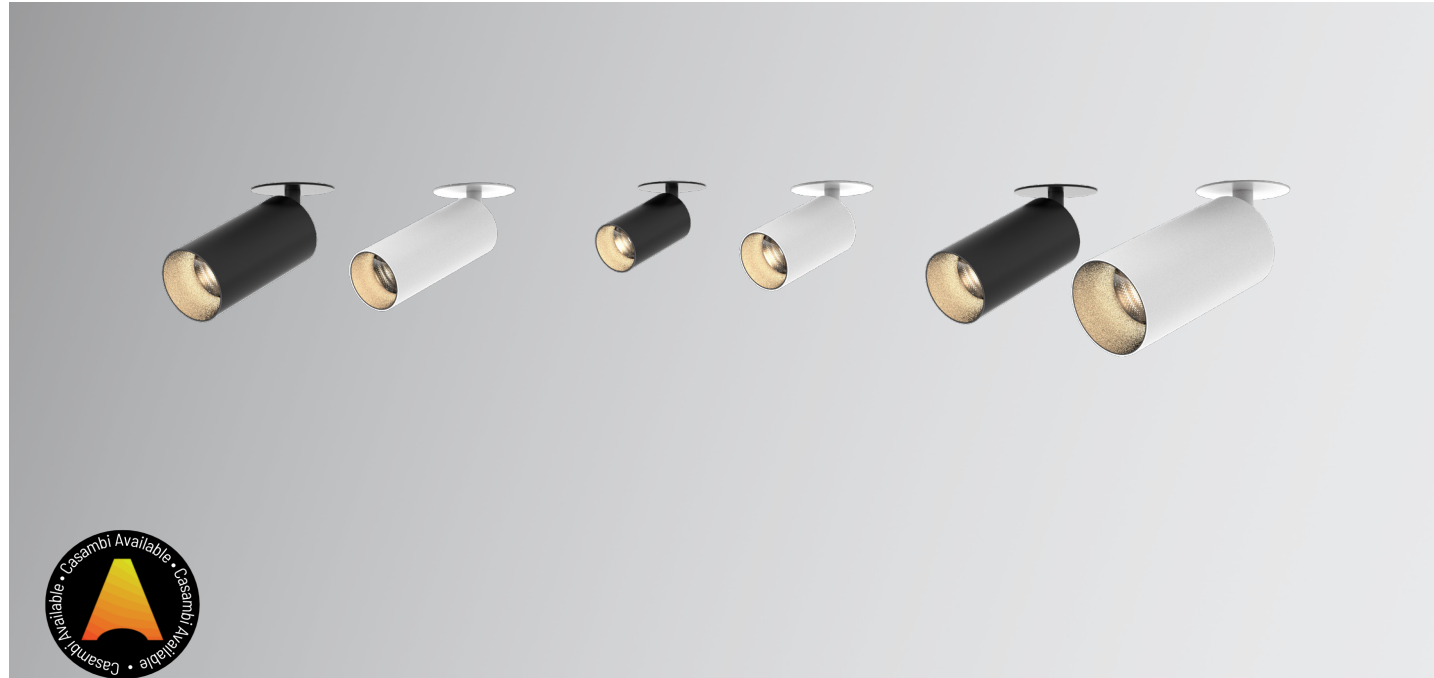

Discover more

Product information

Input voltage	230V
System Power	up to 29,2W
System Lumen	up to 2347lm
Efficacy	up to 84lm/W
CRI	>90Ra
Lens	30° included
CCT	2700K 3000K
Available housing color	White Black
Certification	CE/ROHS

Dimensions

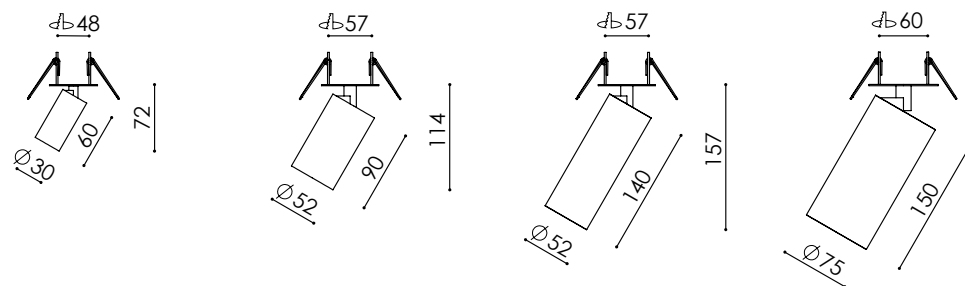

Neo Point

Article No.	Product Name	Housing Color	CCT	CRI	Lumen	Power	Efficacy	Diameter	Lens
2.11.7155 / 2.11.7163*	Neo Point S	White	2700K	>90Ra	467lm	12,4W	38lm/W	Ø36mm	30°
2.11.7156 / 2.11.7164*	Neo Point S	Black	2700K	>90Ra	467lm	12,4W	38lm/W	Ø36mm	30°
2.11.7157 / 2.11.7165*	Neo Point S	White	3000K	>90Ra	508lm	12,5W	41lm/W	Ø36mm	30°
2.11.7158 / 2.11.7166*	Neo Point S	Black	3000K	>90Ra	508lm	12,5W	41lm/W	Ø36mm	30°
2.11.7171 / 2.11.7179*	Neo Point M	White	2700K	>90Ra	1256lm	15,5W	81lm/W	Ø52mm	30°
2.11.7172 / 2.11.7180*	Neo Point M	Black	2700K	>90Ra	1256lm	15,5W	81lm/W	Ø52mm	30°
2.11.7173 / 2.11.7181*	Neo Point M	White	3000K	>90Ra	1322lm	15,7W	84lm/W	Ø52mm	30°
2.11.7174 / 2.11.7182*	Neo Point M	Black	3000K	>90Ra	1322lm	15,7W	84lm/W	Ø52mm	30°
2.11.7187 / 2.11.7199*	Neo Point L	White	2700K	>90Ra	1629lm	21,3W	76lm/W	Ø52mm	30°
2.11.7188 / 2.11.7200*	Neo Point L	Black	2700K	>90Ra	1629lm	21,3W	76lm/W	Ø52mm	30°
2.11.7189 / 2.11.7201*	Neo Point L	White	3000K	>90Ra	1753lm	21,4W	82lm/W	Ø52mm	30°
2.11.7190 / 2.11.7202*	Neo Point L	Black	3000K	>90Ra	1753lm	21,4W	82lm/W	Ø52mm	30°
2.11.7207 / 2.11.7219*	Neo Point XL	White	2700K	>90Ra	2278lm	29,2W	78lm/W	Ø75mm	30°
2.11.7208 / 2.11.7220*	Neo Point XL	Black	2700K	>90Ra	2278lm	29,2W	78lm/W	Ø75mm	30°
2.11.7209 / 2.11.7221*	Neo Point XL	White	3000K	>90Ra	2347lm	29W	81lm/W	Ø75mm	30°
2.11.7210 / 2.11.7222*	Neo Point XL	Black	3000K	>90Ra	2347lm	29W	81lm/W	Ø75mm	30°

Article No. With * indicates that the luminaire is DALI Dimmable.

Adjustable Accessories

Article No.	Product Name	Article No.	Product Name
2.01.1086	Inner ring for Neo M/L - Gold	5.14.0246	50° reflector for Neo S
2.01.1288	Inner ring for Neo M/L - White	5.14.0247	15° reflector for Neo M/L
2.01.1088	Inner ring for Neo XL - Gold	5.14.0249	50° reflector for Neo M/L
2.01.1289	Inner ring for Neo XL - White	5.14.0250	15° reflector for Neo XL
2.01.1152	Honeycomb for Neo M/L	5.14.0252	50° reflector for Neo XL
2.01.1153	Honeycomb for Neo XL		

Neo ON AIM



Discover more

Product information

Input voltage	230V
Power	up to 29,2W
Lumen output	up to 2347lm
Efficacy	up to 84lm/W
CRI	>90Ra
Lens	30° included
CCT	2700K 3000K
Available housing color	White Black
Certification	CE/ROHS

Dimensions

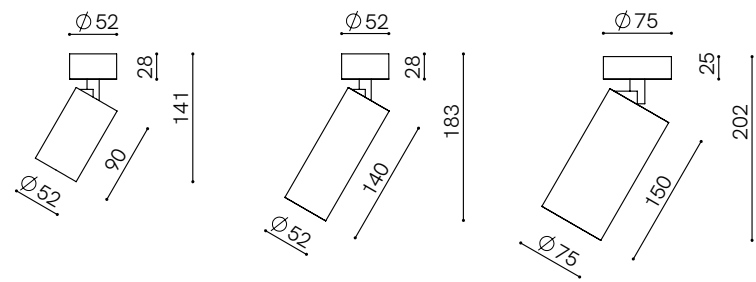

All articles in this sheet are fitted With an external driver.

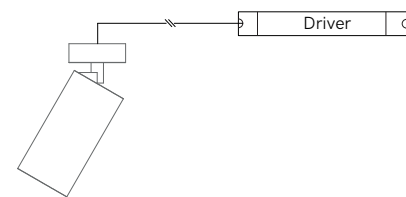

Neo On Aim

Article No.	Product Name	Housing Color	CCT	CRI	Lumen	Power	Efficacy	Diameter	Lens
2.17.4105 / 2.17.4113*	Neo On Aim M	White	2700K	>90Ra	1256lm	15,5W	81lm/W	$\varnothing 52$ mm	30°
2.17.4106 / 2.17.4114*	Neo On Aim M	Black	2700K	>90Ra	1256lm	15,5W	81lm/W	$\varnothing 52$ mm	30°
2.17.4107 / 2.17.4115*	Neo On Aim M	White	3000K	>90Ra	1322lm	15,7W	84lm/W	$\varnothing 52$ mm	30°
2.17.4108 / 2.17.4116*	Neo On Aim M	Black	3000K	>90Ra	1322lm	15,7W	84lm/W	$\varnothing 52$ mm	30°
2.17.4121 / 2.17.4133*	Neo On Aim L	White	2700K	>90Ra	1629lm	21,3W	76lm/W	$\varnothing 52$ mm	30°
2.17.4122 / 2.17.4134*	Neo On Aim L	Black	2700K	>90Ra	1629lm	21,3W	76lm/W	$\varnothing 52$ mm	30°
2.17.4123 / 2.17.4135*	Neo On Aim L	White	3000K	>90Ra	1753lm	21,4W	82lm/W	$\varnothing 52$ mm	30°
2.17.4124 / 2.17.4136*	Neo On Aim L	Black	3000K	>90Ra	1753lm	21,4W	82lm/W	$\varnothing 52$ mm	30°
2.17.4141 / 2.17.4153*	Neo On Aim XL	White	2700K	>90Ra	2278lm	29,2W	78lm/W	$\varnothing 75$ mm	30°
2.17.4142 / 2.17.4154*	Neo On Aim XL	Black	2700K	>90Ra	2278lm	29,2W	78lm/W	$\varnothing 75$ mm	30°
2.17.4143 / 2.17.4155*	Neo On Aim XL	White	3000K	>90Ra	2347lm	29W	81lm/W	$\varnothing 75$ mm	30°
2.17.4144 / 2.17.4156*	Neo On Aim XL	Black	3000K	>90Ra	2347lm	29W	81lm/W	$\varnothing 75$ mm	30°

Article No. With * indicates that the luminaire is DALI Dimmable.

Adjustable Accessories

Article No.	Product Name	Article No.	Product Name
2.01.1086	Inner ring for Neo M/L - Gold	5.14.0247	15° reflector for Neo M/L
2.01.1288	Inner ring for Neo M/L - White	5.14.0249	50° reflector for Neo M/L
2.01.1088	Inner ring for Neo XL - Gold	5.14.0250	15° reflector for Neo XL
2.01.1289	Inner ring for Neo XL - White	5.14.0252	50° reflector for Neo XL
2.01.1152	Honeycomb for Neo M/L		
2.01.1153	Honeycomb for Neo XL		



Neo IN

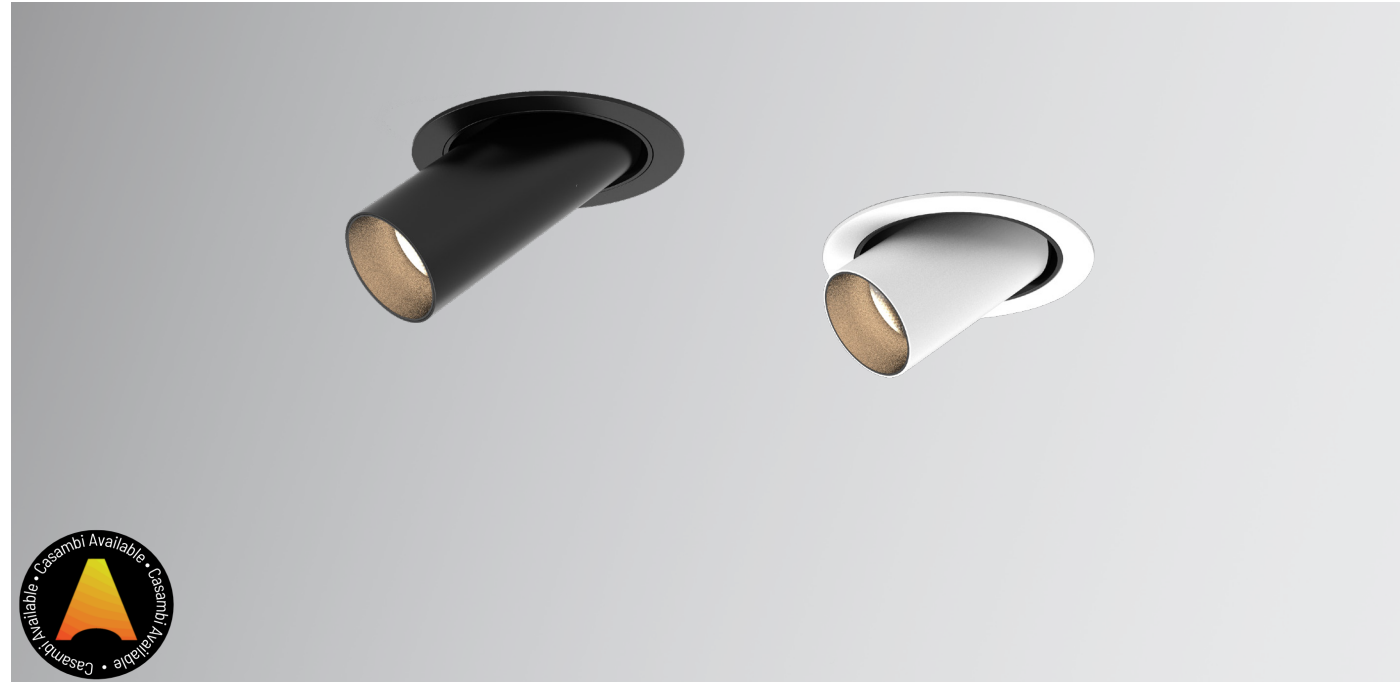

Discover more

Product information

Input voltage	230V
Power	20,3W
Lumen output	up to 1753lm
Efficacy	up to 84lm/W
CRI	>90Ra
Lens	30° included
CCT	2700K 3000K
Available housing color	White Black
Certification	CE/ROHS

Dimensions

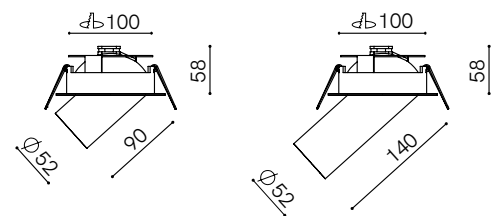

Neo In

Article No.	Product Name	Housing Color	Inner Ring Color	Outer Ring Color	CCT	CRI	System Lumen	System Power	System Efficacy	Diameter	Lens
2.11.7027 / 2.11.7059*	Neo In M	White	White	White	2700K	>90Ra	1256lm	16,8W	81lm/W	Ø52mm	30°
2.11.7028 / 2.11.7060*	Neo In M	White	White	Black	2700K	>90Ra	1256lm	16,8W	81lm/W	Ø52mm	30°
2.11.7029 / 2.11.7061*	Neo In M	White	Black	White	2700K	>90Ra	1256lm	16,8W	81lm/W	Ø52mm	30°
2.11.7030 / 2.11.7062*	Neo In M	White	Black	Black	2700K	>90Ra	1256lm	16,8W	81lm/W	Ø52mm	30°
2.11.7031 / 2.11.7063*	Neo In M	Black	White	White	2700K	>90Ra	1256lm	16,8W	81lm/W	Ø52mm	30°
2.11.7032 / 2.11.7064*	Neo In M	Black	White	Black	2700K	>90Ra	1256lm	16,8W	81lm/W	Ø52mm	30°
2.11.7033 / 2.11.7065*	Neo In M	Black	Black	White	2700K	>90Ra	1256lm	16,8W	81lm/W	Ø52mm	30°
2.11.7034 / 2.11.7066*	Neo In M	Black	Black	Black	2700K	>90Ra	1256lm	16,8W	81lm/W	Ø52mm	30°
2.11.7035 / 2.11.7067*	Neo In M	White	White	White	3000K	>90Ra	1322lm	17W	84lm/W	Ø52mm	30°
2.11.7036 / 2.11.7068*	Neo In M	White	White	Black	3000K	>90Ra	1322lm	17W	84lm/W	Ø52mm	30°
2.11.7037 / 2.11.7069*	Neo In M	White	Black	White	3000K	>90Ra	1322lm	17W	84lm/W	Ø52mm	30°
2.11.7038 / 2.11.7070*	Neo In M	White	Black	Black	3000K	>90Ra	1322lm	17W	84lm/W	Ø52mm	30°
2.11.7039 / 2.11.7071*	Neo In M	Black	White	White	3000K	>90Ra	1322lm	17W	84lm/W	Ø52mm	30°
2.11.7040 / 2.11.7072*	Neo In M	Black	White	Black	3000K	>90Ra	1322lm	17W	84lm/W	Ø52mm	30°
2.11.7041 / 2.11.7073*	Neo In M	Black	Black	White	3000K	>90Ra	1322lm	17W	84lm/W	Ø52mm	30°
2.11.7042 / 2.11.7074*	Neo In M	Black	Black	Black	3000K	>90Ra	1322lm	17W	84lm/W	Ø52mm	30°
2.11.7091 / 2.11.7123*	Neo In L	White	White	White	2700K	>90Ra	1629lm	21,3W	76lm/W	Ø52mm	30°
2.11.7092 / 2.11.7124*	Neo In L	White	Black	Black	2700K	>90Ra	1629lm	21,3W	76lm/W	Ø52mm	30°
2.11.7093 / 2.11.7125*	Neo In L	Black	White	White	2700K	>90Ra	1629lm	21,3W	76lm/W	Ø52mm	30°
2.11.7094 / 2.11.7126*	Neo In L	Black	Black	Black	2700K	>90Ra	1629lm	21,3W	76lm/W	Ø52mm	30°
2.11.7095 / 2.11.7127*	Neo In L	White	White	White	2700K	>90Ra	1629lm	21,3W	76lm/W	Ø52mm	30°
2.11.7096 / 2.11.7128*	Neo In L	White	Black	Black	2700K	>90Ra	1629lm	21,3W	76lm/W	Ø52mm	30°
2.11.7097 / 2.11.7129*	Neo In L	Black	White	White	2700K	>90Ra	1629lm	21,3W	76lm/W	Ø52mm	30°
2.11.7098 / 2.11.7130*	Neo In L	Black	Black	Black	2700K	>90Ra	1629lm	21,3W	76lm/W	Ø52mm	30°
2.11.7099 / 2.11.7131*	Neo In L	White	White	White	3000K	>90Ra	1753lm	21,4W	82lm/W	Ø52mm	30°
2.11.7100 / 2.11.7132*	Neo In L	White	Black	Black	3000K	>90Ra	1753lm	21,4W	82lm/W	Ø52mm	30°
2.11.7101 / 2.11.7133*	Neo In L	Black	White	White	3000K	>90Ra	1753lm	21,4W	82lm/W	Ø52mm	30°
2.11.7102 / 2.11.7134*	Neo In L	Black	Black	Black	3000K	>90Ra	1753lm	21,4W	82lm/W	Ø52mm	30°
2.11.7103 / 2.11.7135*	Neo In L	White	White	White	3000K	>90Ra	1753lm	21,4W	82lm/W	Ø52mm	30°
2.11.7104 / 2.11.7136*	Neo In L	White	Black	Black	3000K	>90Ra	1753lm	21,4W	82lm/W	Ø52mm	30°
2.11.7105 / 2.11.7137*	Neo In L	Black	White	White	3000K	>90Ra	1753lm	21,4W	82lm/W	Ø52mm	30°
2.11.7106 / 2.11.7138*	Neo In L	Black	Black	Black	3000K	>90Ra	1753lm	21,4W	82lm/W	Ø52mm	30°

Article No. With * indicates that the luminaire is DALI Dimmable.

Adjustable Accessories

Article No.	Product Name	Article No.	Product Name
2.01.1086	Inner ring for Neo M/L - Gold	5.14.0247	15° reflector for Neo M/L
2.01.1288	Inner ring for Neo M/L - White	5.14.0249	50° reflector for Neo M/L
2.01.1152	Honeycomb for Neo M/L		

Neo IN - TRIMLESS

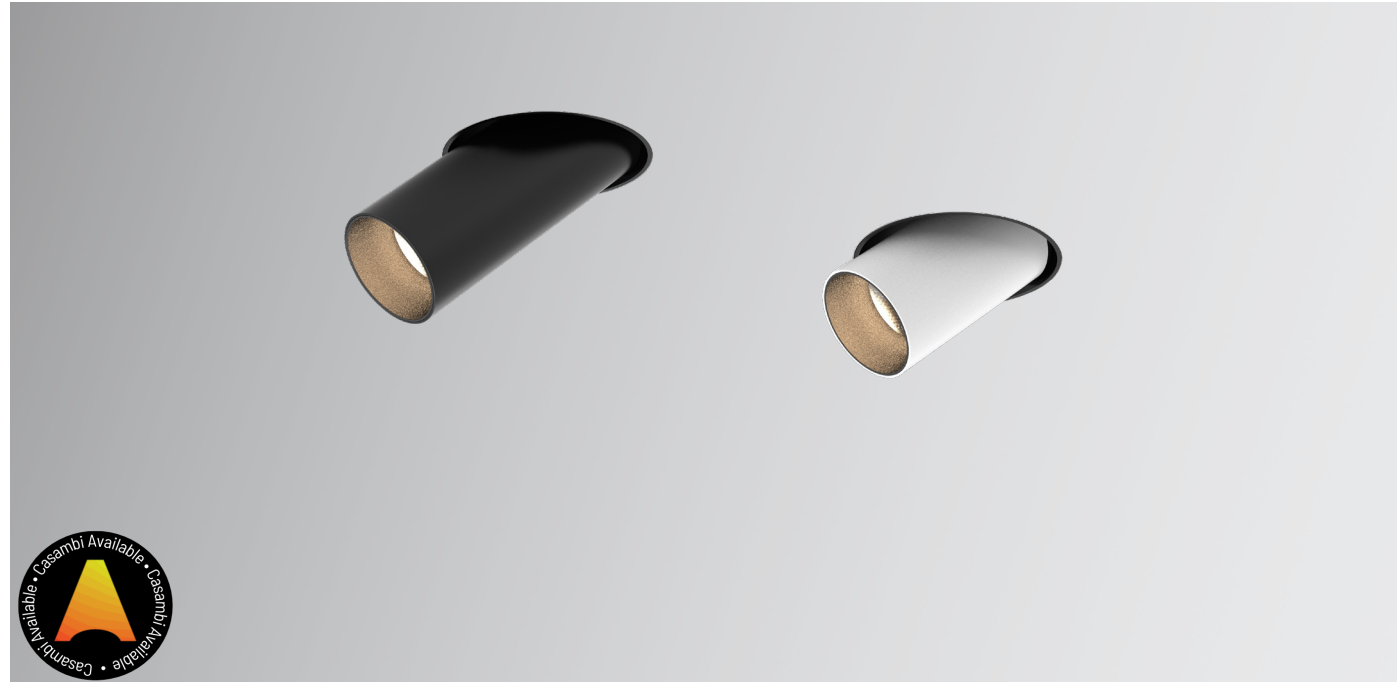

Discover more

Product information

Input voltage	230V
Power	21,4W
Lumen output	up to 1753lm
Efficacy	up to 84lm/W
CRI	>90Ra
Lens	30° included
CCT	2700K 3000K
Available housing color	White Black
Certification	CE/ROHS

Dimensions

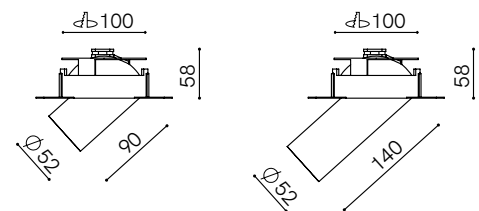

*Plaser frame included

Neo In Trimless

Article No.	Product Name	Housing Color	Inner Ring Color	CCT	CRI	Lumen	Power	System Efficacy	Diameter	Lens
2.11.6963 / 2.11.6979*	Neo In M Trimless	White	White	2700K	>90Ra	1256lm	15,5W	81lm/W	Ø52mm	30°
2.11.6964 / 2.11.6980*	Neo In M Trimless	White	Black	2700K	>90Ra	1256lm	15,5W	81lm/W	Ø52mm	30°
2.11.6965 / 2.11.6981*	Neo In M Trimless	Black	White	2700K	>90Ra	1256lm	15,5W	81lm/W	Ø52mm	30°
2.11.6966 / 2.11.6982*	Neo In M Trimless	Black	Black	2700K	>90Ra	1256lm	15,5W	81lm/W	Ø52mm	30°
2.11.6967 / 2.11.6983*	Neo In M Trimless	White	White	3000K	>90Ra	1322lm	15,7W	84lm/W	Ø52mm	30°
2.11.6968 / 2.11.6984*	Neo In M Trimless	White	Black	3000K	>90Ra	1322lm	15,7W	84lm/W	Ø52mm	30°
2.11.6969 / 2.11.6985*	Neo In M Trimless	Black	White	3000K	>90Ra	1322lm	15,7W	84lm/W	Ø52mm	30°
2.11.6970 / 2.11.6986*	Neo In M Trimless	Black	Black	3000K	>90Ra	1322lm	15,7W	84lm/W	Ø52mm	30°
2.11.6995 / 2.11.7011*	Neo In L Trimless	White	White	2700K	>90Ra	1629lm	21,3W	76lm/W	Ø52mm	30°
2.11.6996 / 2.11.7012*	Neo In L Trimless	White	Black	2700K	>90Ra	1629lm	21,3W	76lm/W	Ø52mm	30°
2.11.6997 / 2.11.7013*	Neo In L Trimless	Black	White	2700K	>90Ra	1629lm	21,3W	76lm/W	Ø52mm	30°
2.11.6998 / 2.11.7014*	Neo In L Trimless	Black	Black	2700K	>90Ra	1629lm	21,3W	76lm/W	Ø52mm	30°
2.11.6999 / 2.11.7015*	Neo In L Trimless	White	White	3000K	>90Ra	1753lm	21,4W	82lm/W	Ø52mm	30°
2.11.7000 / 2.11.7016*	Neo In L Trimless	White	Black	3000K	>90Ra	1753lm	21,4W	82lm/W	Ø52mm	30°
2.11.7001 / 2.11.7017*	Neo In L Trimless	Black	White	3000K	>90Ra	1753lm	21,4W	82lm/W	Ø52mm	30°
2.11.7002 / 2.11.7018*	Neo In L Trimless	Black	Black	3000K	>90Ra	1753lm	21,4W	82lm/W	Ø52mm	30°

Article No. With * indicates that the luminaire is DALI Dimmable.

Adjustable Accessories

Article No.	Product Name	Article No.	Product Name
2.01.1086	Inner ring for Neo M/L - Gold	5.14.0247	15° reflector for Neo M/L
2.01.1288	Inner ring for Neo M/L - White	5.14.0249	50° reflector for Neo M/L
2.01.1152	Honeycomb for Neo M/L		



Neo TRACK

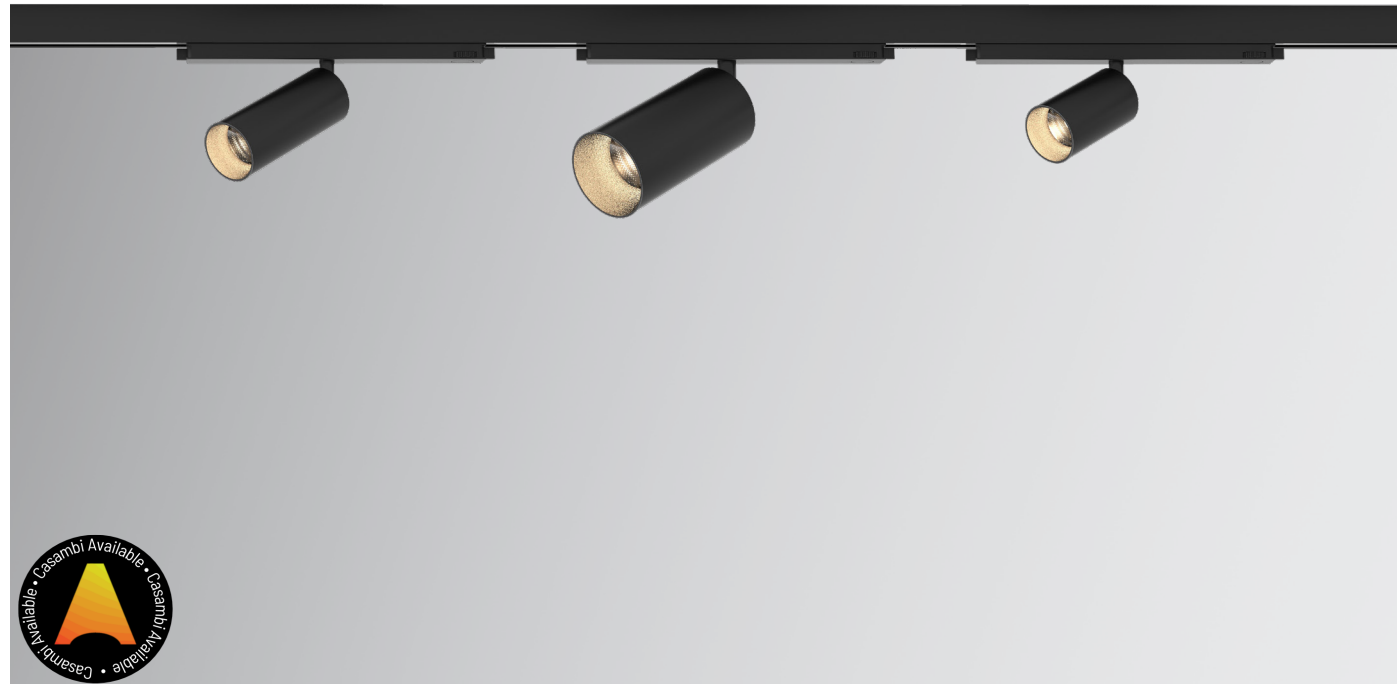

Product information

Input voltage	230V
Power	35W
Lumen output	up to 3092lm
Efficacy	up to 98lm/W
CRI	>90Ra
Lens	30° included
CCT	2700K 3000K
Available housing color	White Black
Certification	CE/ROHS



Discover more

Max. dimensions

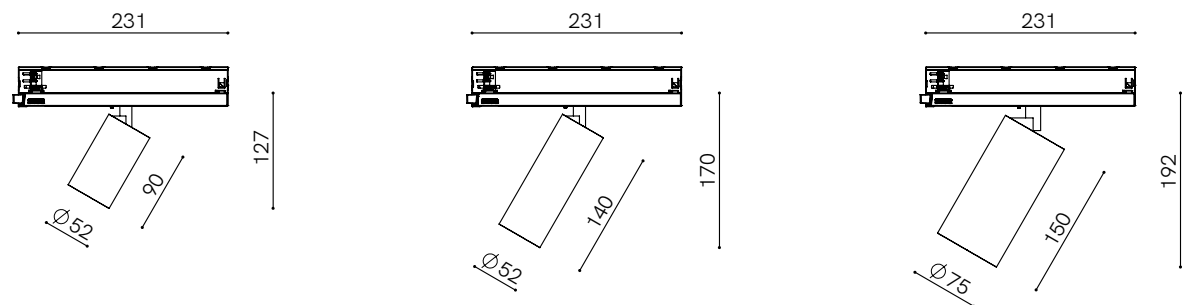

Neo Track

Article No.	Product Name	Housing Color	Inner Ring Color	CCT	CRI	Lumen	Power	Efficacy	Diameter	Lens
2.17.3348 / 2.17.3420*	Neo Track M	Black	Black	2700K	>90Ra	1010lm	11,8W	85lm/W	Ø52mm	30°
2.17.3349 / 2.17.3421*	Neo Track M	Black	Gold	2700K	>90Ra	1010lm	11,8W	85lm/W	Ø52mm	30°
2.17.3350 / 2.17.3422*	Neo Track M	White	Black	2700K	>90Ra	1010lm	11,8W	85lm/W	Ø52mm	30°
2.17.3351 / 2.17.3423*	Neo Track M	White	Gold	2700K	>90Ra	1010lm	11,8W	85lm/W	Ø52mm	30°
2.17.3360 / 2.17.3432*	Neo Track M	Black	Black	3000K	>90Ra	1098lm	11,9W	92lm/W	Ø52mm	30°
2.17.3361 / 2.17.3433*	Neo Track M	Black	Gold	3000K	>90Ra	1098lm	11,9W	92lm/W	Ø52mm	30°
2.17.3362 / 2.17.3434*	Neo Track M	White	Black	3000K	>90Ra	1098lm	11,9W	92lm/W	Ø52mm	30°
2.17.3363 / 2.17.3435*	Neo Track M	White	Gold	3000K	>90Ra	1098lm	11,9W	92lm/W	Ø52mm	30°
2.17.3372 / 2.17.3444*	Neo Track L	Black	Black	2700K	>90Ra	1385lm	15,5W	89lm/W	Ø52mm	30°
2.17.3373 / 2.17.3445*	Neo Track L	Black	Gold	2700K	>90Ra	1385lm	15,5W	89lm/W	Ø52mm	30°
2.17.3374 / 2.17.3446*	Neo Track L	White	Black	2700K	>90Ra	1385lm	15,5W	89lm/W	Ø52mm	30°
2.17.3375 / 2.17.3447*	Neo Track L	White	Gold	2700K	>90Ra	1385lm	15,5W	89lm/W	Ø52mm	30°
2.17.3384 / 2.17.3456*	Neo Track L	Black	Black	3000K	>90Ra	1505lm	15,4W	98lm/W	Ø52mm	30°
2.17.3385 / 2.17.3457*	Neo Track L	Black	Gold	3000K	>90Ra	1505lm	15,4W	98lm/W	Ø52mm	30°
2.17.3386 / 2.17.3458*	Neo Track L	White	Black	3000K	>90Ra	1505lm	15,4W	98lm/W	Ø52mm	30°
2.17.3387 / 2.17.3459*	Neo Track L	White	Gold	3000K	>90Ra	1505lm	15,4W	98lm/W	Ø52mm	30°
2.17.3396 / 2.17.3468*	Neo Track XL	Black	Black	2700K	>90Ra	2845lm	34,5	82lm/W	Ø75mm	30°
2.17.3397 / 2.17.3469*	Neo Track XL	Black	Gold	2700K	>90Ra	2845lm	34,5	82lm/W	Ø75mm	30°
2.17.3398 / 2.17.3470*	Neo Track XL	White	Black	2700K	>90Ra	2845lm	34,5	82lm/W	Ø75mm	30°
2.17.3399 / 2.17.3471*	Neo Track XL	White	Gold	2700K	>90Ra	2845lm	34,5	82lm/W	Ø75mm	30°
2.17.3408 / 2.17.3480*	Neo Track XL	Black	Black	3000K	>90Ra	3092lm	35W	88lm/W	Ø75mm	30°
2.17.3409 / 2.17.3481*	Neo Track XL	Black	Gold	3000K	>90Ra	3092lm	35W	88lm/W	Ø75mm	30°
2.17.3410 / 2.17.3482*	Neo Track XL	White	Black	3000K	>90Ra	3092lm	35W	88lm/W	Ø75mm	30°
2.17.3411 / 2.17.3483*	Neo Track XL	White	Gold	3000K	>90Ra	3092lm	35W	88lm/W	Ø75mm	30°

Article No. With * indicates that the luminaire is DALI Dimmable.

Adjustable Accessories

Article No.	Product Name	Article No.	Product Name
2.01.1086	Inner ring for Neo M/L - Gold	5.14.0247	15° reflector for Neo M/L
2.01.1288	Inner ring for Neo M/L - White	5.14.0249	50° reflector for Neo M/L
2.01.1088	Inner ring for Neo XL - Gold	5.14.0250	15° reflector for Neo XL
2.01.1289	Inner ring for Neo XL - White	5.14.0252	50° reflector for Neo XL
2.01.1152	Honeycomb for Neo M/L		
2.01.1153	Honeycomb for Neo XL		

Neo ON



Discover more

Product information

Input voltage	230V
Power	up to 29,2W
Lumen output	up to 2347lm
Efficacy	up to 84lm/W
CRI	>90Ra
Lens	30° included
CCT	2700K 3000K
Available housing color	White Black
Certification	CE/ROHS

Dimensions

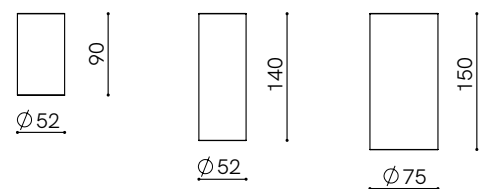

All articles in this sheet are fitted With an external driver.

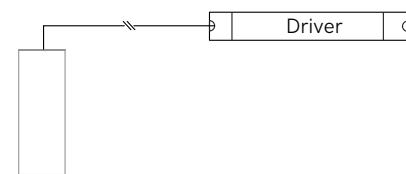

Neo On

Article No.	Product Name	Housing Color	CCT	CRI	Lumen	Power	Efficacy	Diameter	Lens
2.17.4049 / 2.17.4057*	Neo On M	White	2700K	>90Ra	1256lm	15,5W	81lm/W	Ø52 mm	30°
2.17.4050 / 2.17.4058*	Neo On M	Black	2700K	>90Ra	1256lm	15,5W	81lm/W	Ø52 mm	30°
2.17.4051 / 2.17.4059*	Neo On M	White	3000K	>90Ra	1322lm	15,7W	84lm/W	Ø52 mm	30°
2.17.4052 / 2.17.4060*	Neo On M	Black	3000K	>90Ra	1322lm	15,7W	84lm/W	Ø52 mm	30°
2.17.4065 / 2.17.4077*	Neo On L	White	2700K	>90Ra	1629lm	21,3W	76lm/W	Ø52 mm	30°
2.17.4066 / 2.17.4078*	Neo On L	Black	2700K	>90Ra	1629lm	21,3W	76lm/W	Ø52 mm	30°
2.17.4067 / 2.17.4079*	Neo On L	White	3000K	>90Ra	1753lm	21,4W	82lm/W	Ø52 mm	30°
2.17.4068 / 2.17.4080*	Neo On L	Black	3000K	>90Ra	1753lm	21,4W	82lm/W	Ø52 mm	30°
2.17.4085 / 2.17.4097*	Neo On XL	White	2700K	>90Ra	2278lm	29,2W	78lm/W	Ø75 mm	30°
2.17.4086 / 2.17.4098*	Neo On XL	Black	2700K	>90Ra	2278lm	29,2W	78lm/W	Ø75 mm	30°
2.17.4087 / 2.17.4099*	Neo On XL	White	3000K	>90Ra	2347lm	29W	81lm/W	Ø75 mm	30°
2.17.4088 / 2.17.4100*	Neo On XL	Black	3000K	>90Ra	2347lm	29W	81lm/W	Ø75 mm	30°

Article No. With * indicates that the luminaire is DALI Dimmable.

Adjustable Accessories

Article No.	Product Name	Article No.	Product Name
2.01.1086	Inner ring for Neo M/L - Gold	5.14.0247	15° reflector for Neo M/L
2.01.1288	Inner ring for Neo M/L - White	5.14.0249	50° reflector for Neo M/L
2.01.1088	Inner ring for Neo XL - Gold	5.14.0250	15° reflector for Neo XL
2.01.1289	Inner ring for Neo XL - White	5.14.0252	50° reflector for Neo XL
2.01.1152	Honeycomb for Neo M/L		
2.01.1153	Honeycomb for Neo XL		



Neo AIR AND BALL



Product information

Input voltage	230V AC
Power	up to 20,8W
Lumen output	up to 1850lm
Efficacy	up to 90lm / W
CRI	>90Ra
Lens	30° for Ø30 (included) 30° for Ø52 (included)
CCT	2700K / 3000K
Available color	White / Black
Certification	CE / ROHS

Product information

Input voltage	230V AC
Power	31,7W
Lumen output	up to 2691lm
Efficacy	up to 86lm / W
CRI	>90Ra
Cover	Opal
CCT	2700K / 3000K
Available color	Black
Certification	CE / ROHS



Discover more

Dimensions

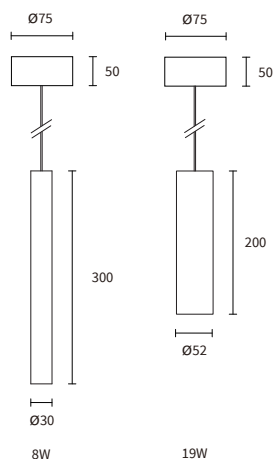

For DALI Dimmable version:
Ø130mm ceiling cap

Cable: 2.5m
Cable can be shortened
to desired length.

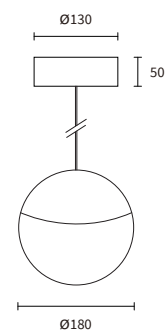

Pendant Lights

Article No.	Product Name	Housing Color	CCT	CRI	Lumen	Power	Efficacy	Diameter	Lens
2.06.0823 / 2.06.0839*	Neo Air S	White	2700K	>90Ra	581lm	8W	72lm / W	Ø30 mm	30°
2.06.0824 / 2.06.0840*	Neo Air S	Black	2700K	>90Ra	581lm	8W	72lm / W	Ø30 mm	30°
2.06.0825 / 2.06.0841*	Neo Air S	White	3000K	>90Ra	617lm	8W	77lm / W	Ø30 mm	30°
2.06.0826 / 2.06.0842*	Neo Air S	Black	3000K	>90Ra	617lm	8W	77lm / W	Ø30 mm	30°
2.06.0827 / 2.06.0843*	Neo Air M	White	2700K	>90Ra	1763lm	20,8W	85lm / W	Ø52 mm	30°
2.06.0828 / 2.06.0844*	Neo Air M	Black	2700K	>90Ra	1763lm	20,8W	85lm / W	Ø52 mm	30°
2.06.0829 / 2.06.0845*	Neo Air M	White	3000K	>90Ra	1850m	20,6W	90lm / W	Ø52 mm	30°
2.06.0830 / 2.06.0846*	Neo Air M	Black	3000K	>90Ra	1850m	20,6W	90lm / W	Ø52 mm	30°
2.06.0804 / 2.06.0812*	Neo Ball	Black	2700K	>90Ra	2425lm	31,7W	76lm / W	Ø180 mm	Opal
2.06.0806 / 2.06.0814*	Neo Ball	Black	3000K	>90Ra	2691lm	31,7W	86lm / W	Ø180 mm	Opal

Article No. With * indicates that the luminaire is DALI Dimmable.

Pendant Lights Accessories

Article No.	Product Name
2.01.1084	Inner ring gold for Arcano Spotty mini 30 / Neo for Ø30
2.01.1086	Inner ring gold for Arcano medium / Neo M en L for Ø52
5.14.0246	Reflector 50° for track spotlight Arcano Spotty for Ø30
5.14.0247	Reflector 15° for Arcano medium / Neo M en L for Ø52
5.14.0249	Reflector 50° for Arcano medium / Neo M en L for Ø52

Pendant Lights Accessories | Available for Ø30 / Ø52 Pendant Lights



50° Lens
for Ø30



15° / 50° Lens
for Ø52

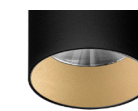

Golden Inner Ring
for Ø30 / Ø52



Credits
VISUALS imore.
GRAPHIC DESIGN Studio Anouk Stoffels

Nijverheidsweg 2
2421LR Nieuwkoop
+31 (0)172 574500
info@nuudo.com
www.nuudo.com

nuudo. is part of the Lumiparts Group